

迷路の一例

- START → GOALまで
- 最短経路を求める

- 左手法
 - 左手を壁伝いに迷路を回るとゴールに到達

- 左手法：無駄な経路アリ

- 最短経路
START → 直進,
四つ角 → 右 → GOAL

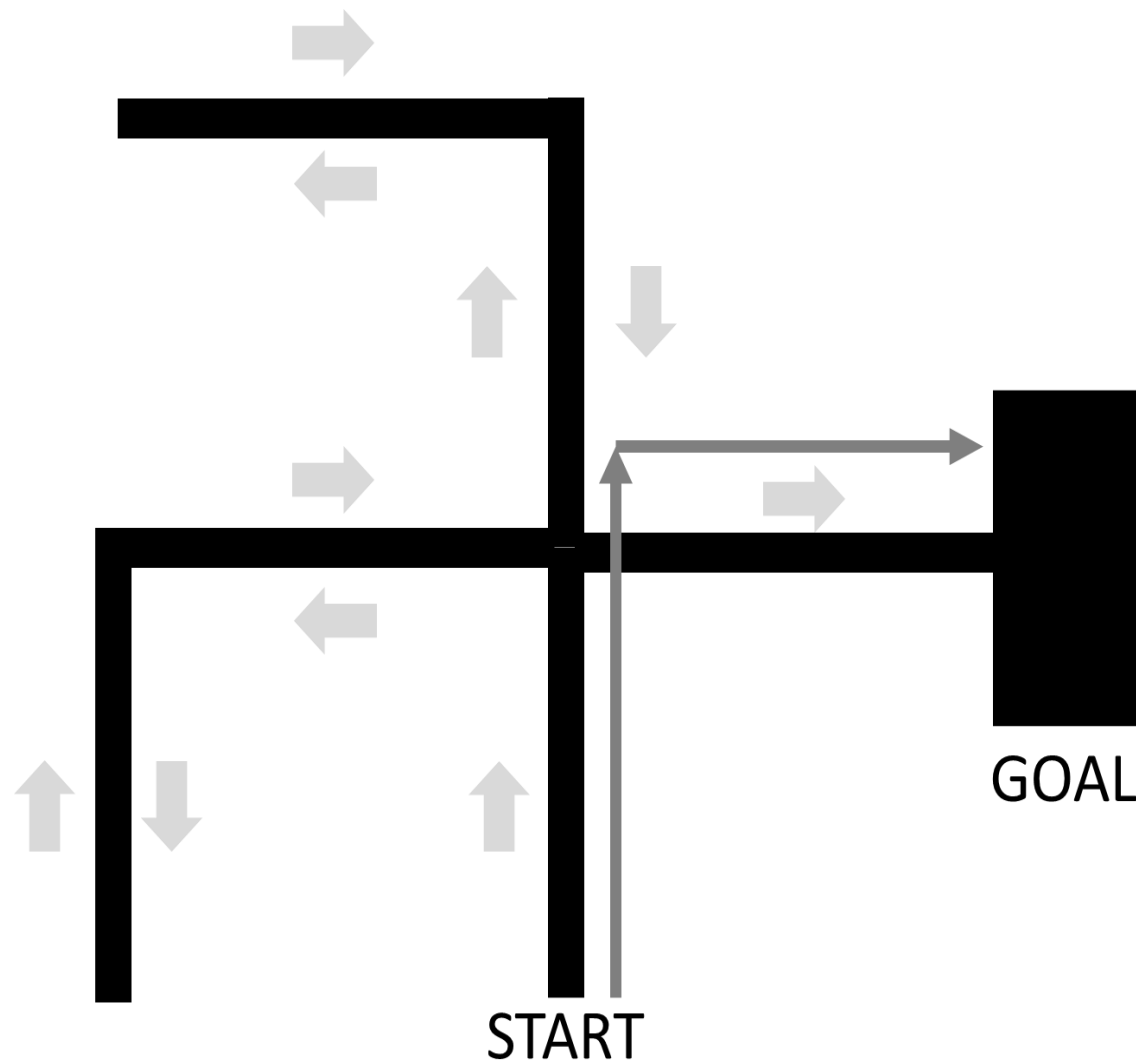

迷路の基本パターン(8つ)

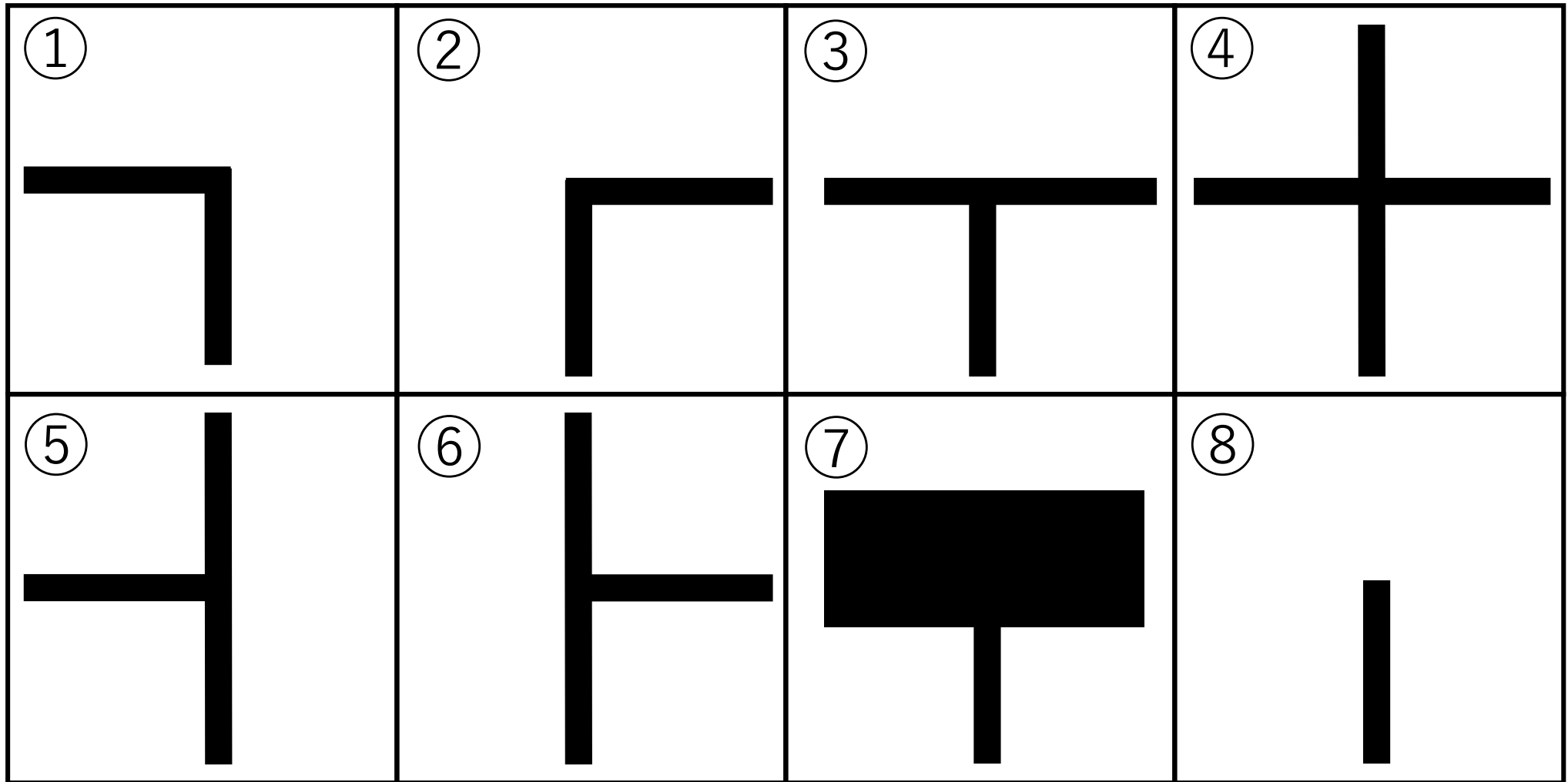

ロボットの車体寸法

– 迷路を解くためには…

正確なロボットの動作が必要！

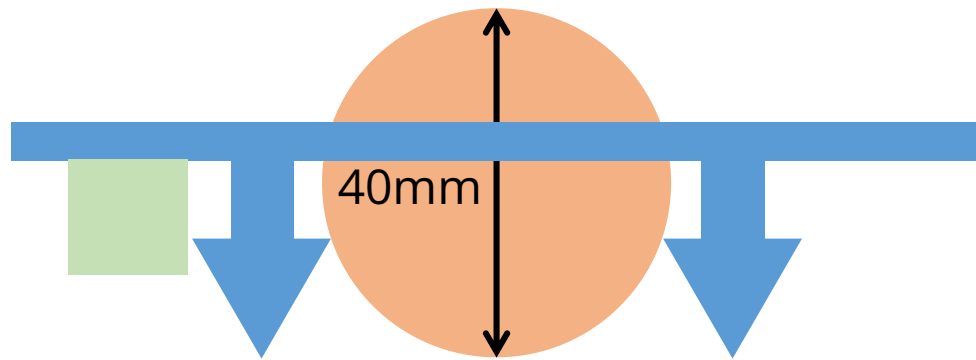

直径 $d = 40$ [mm]

車輪1回転：円周(c) = 直径(d) $\times \pi$ (3.14) = 125.6 [mm]

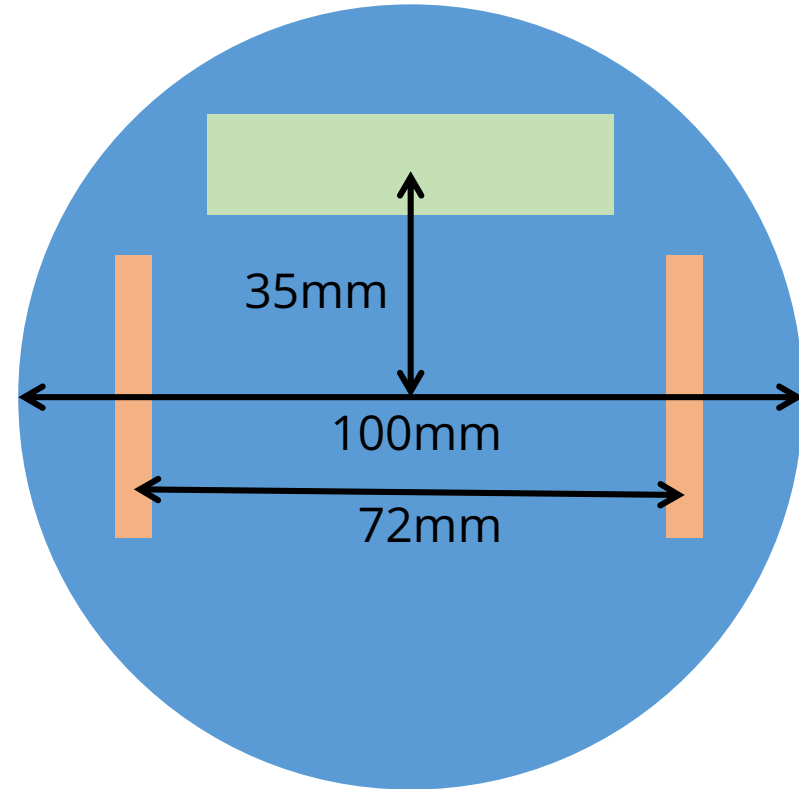

②少し進む
センサ確認

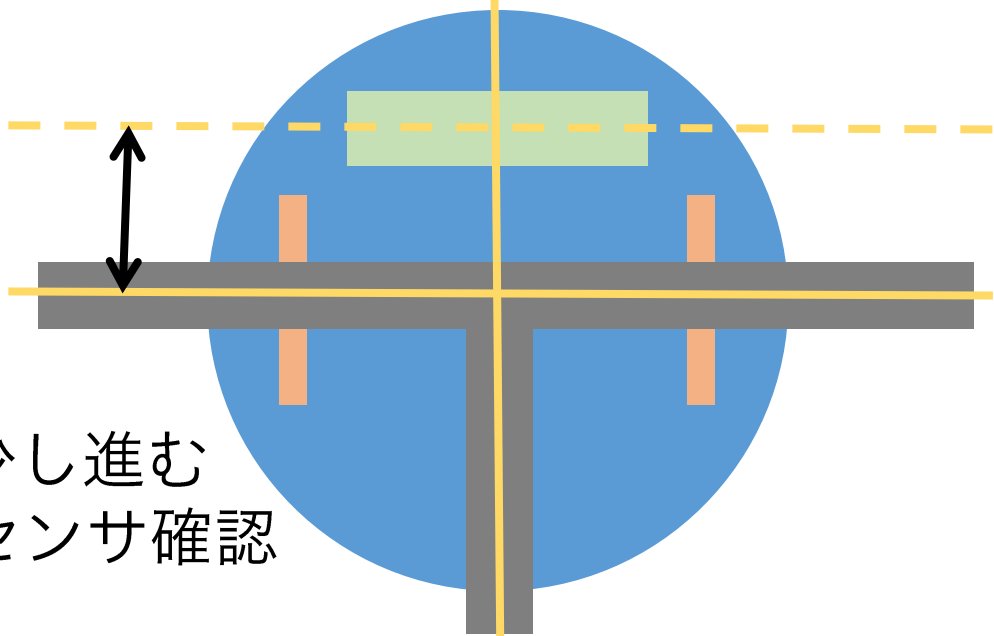

①ライトレース
センサ反応

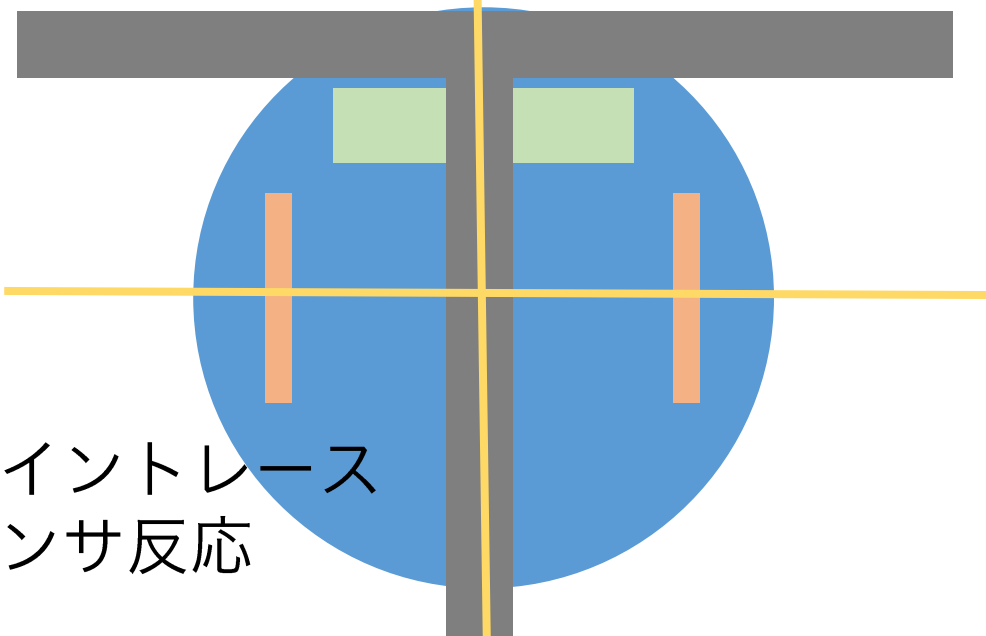

③左 180度旋回

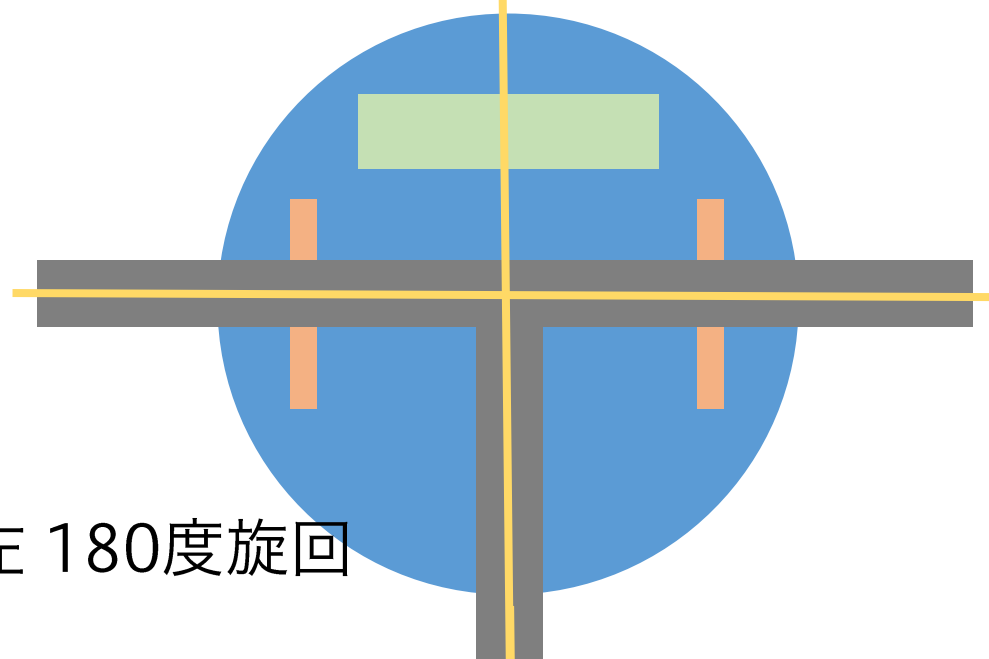

④ライトレース

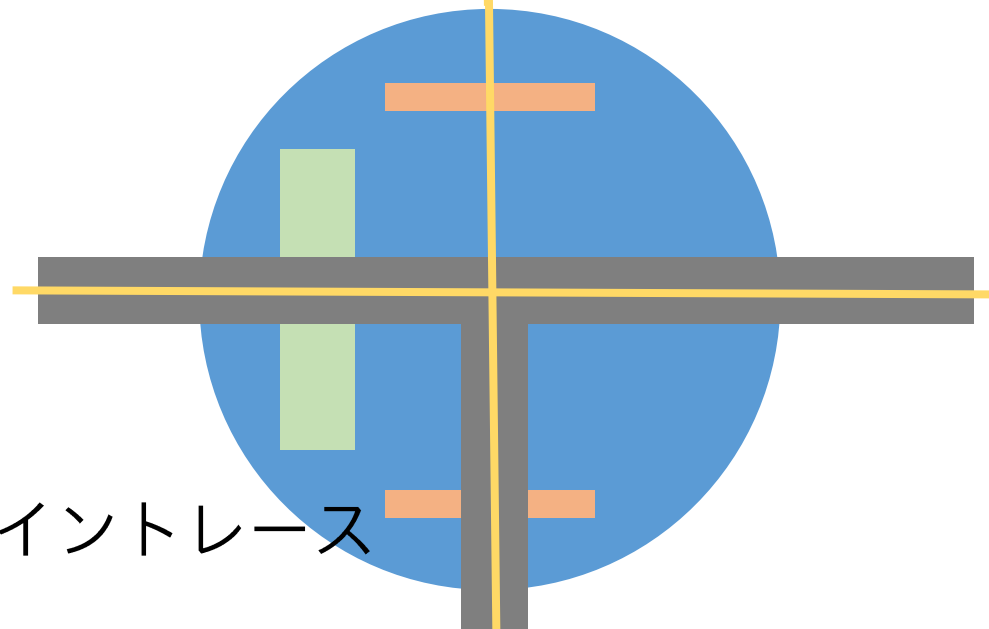

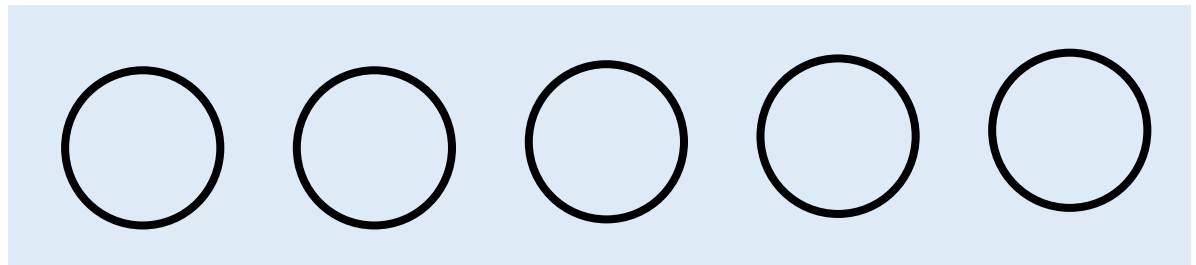
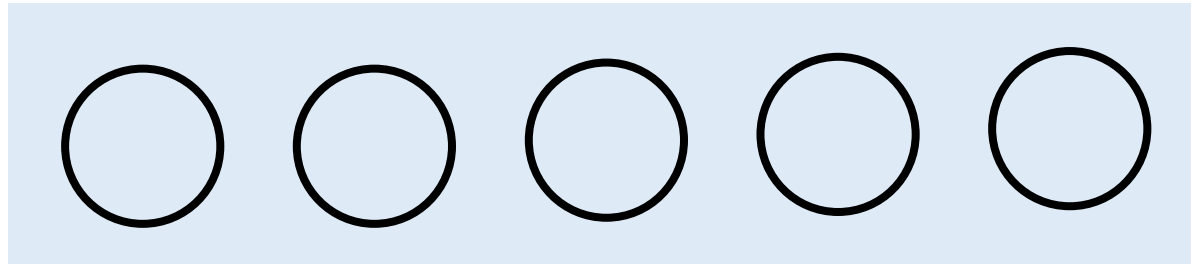
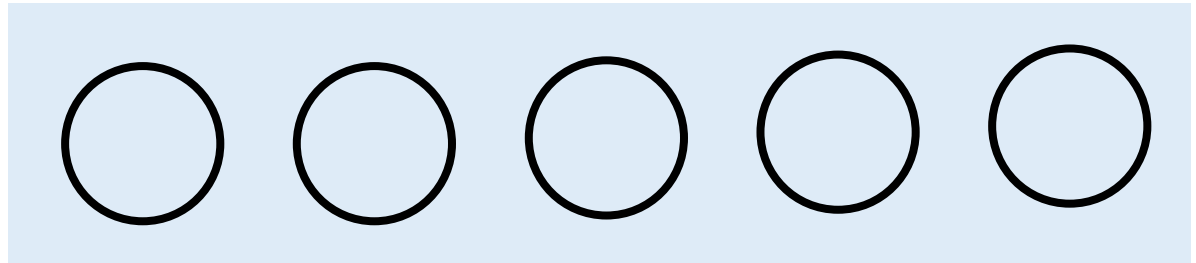
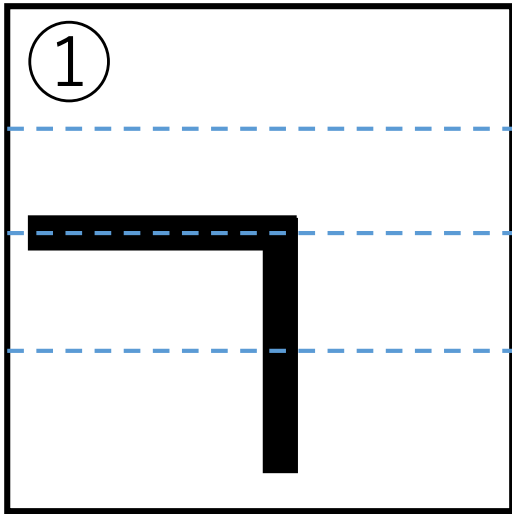

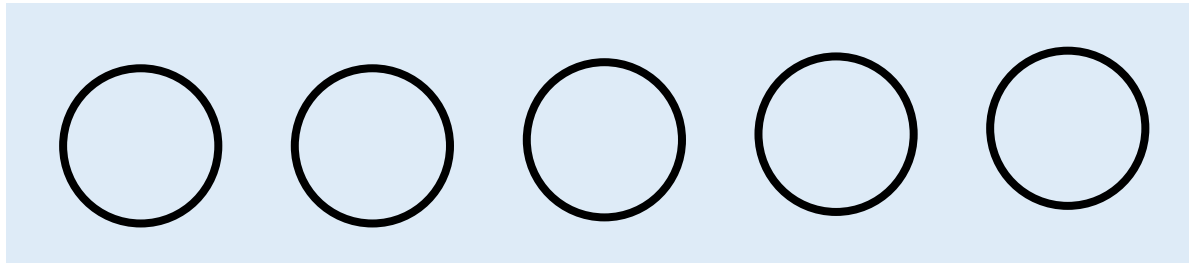
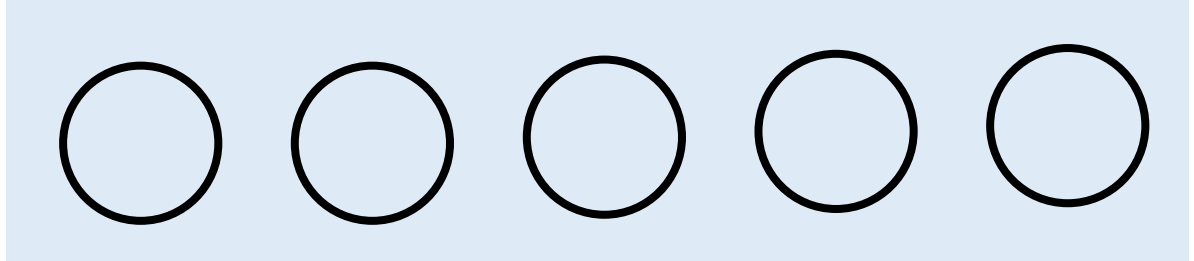
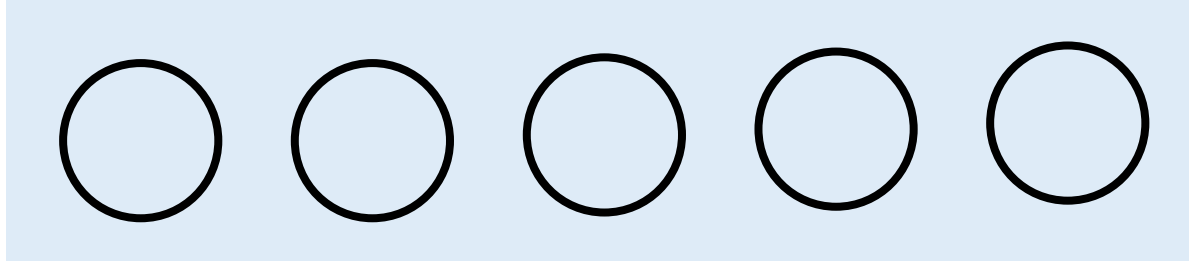
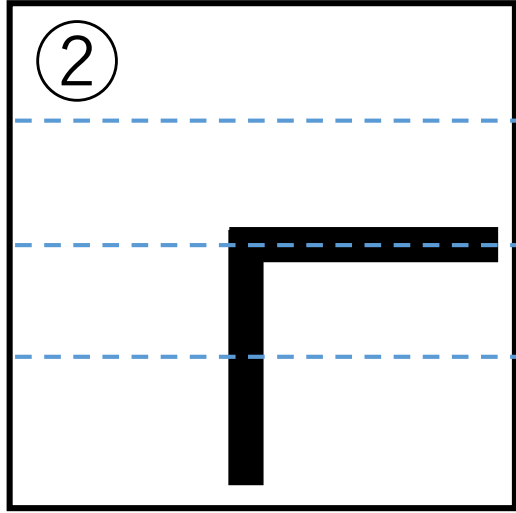

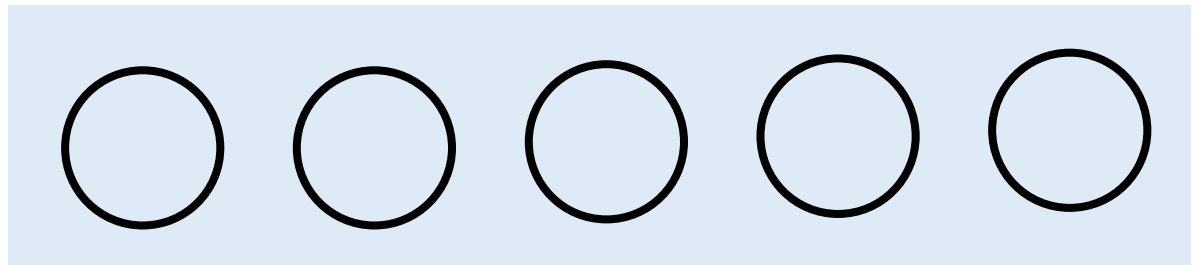
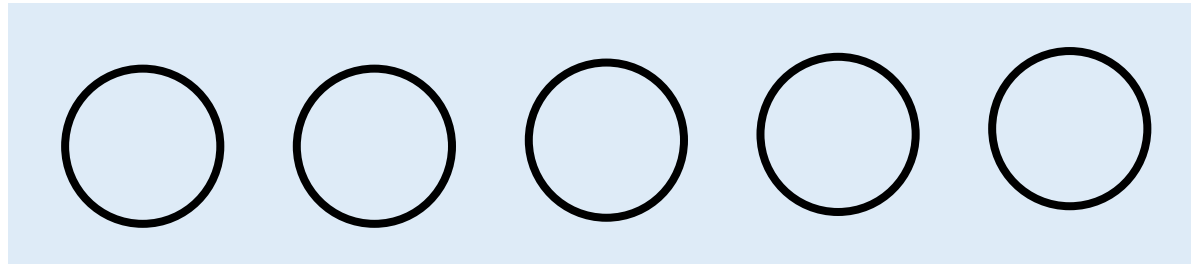
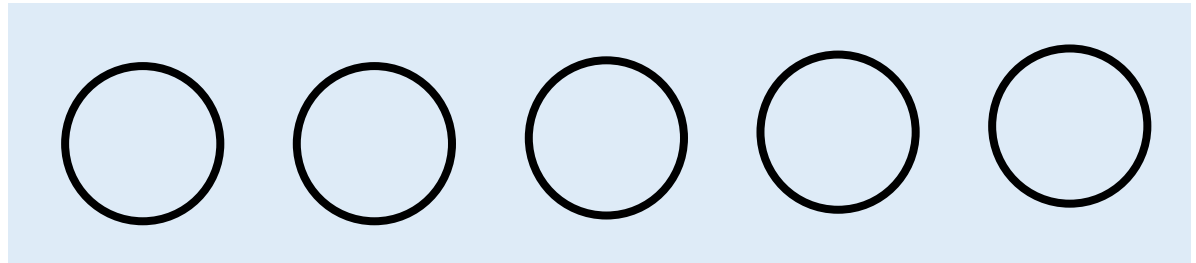
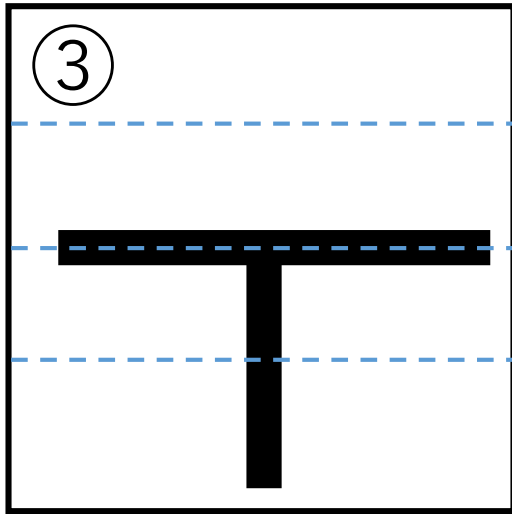

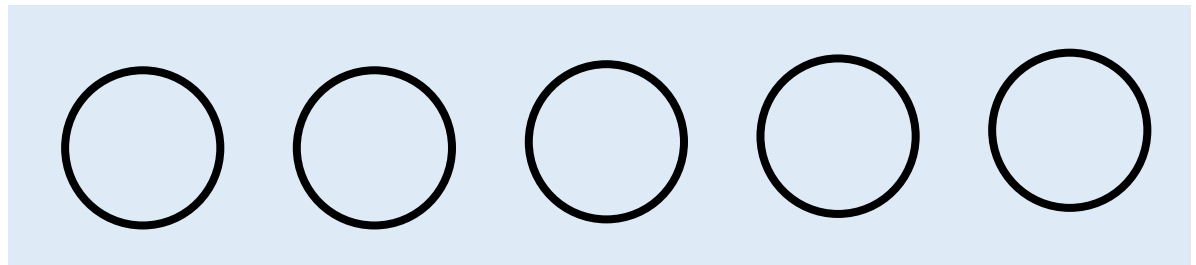
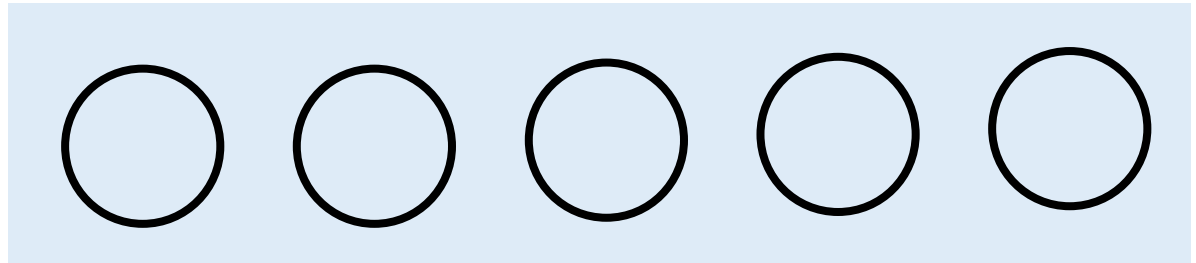
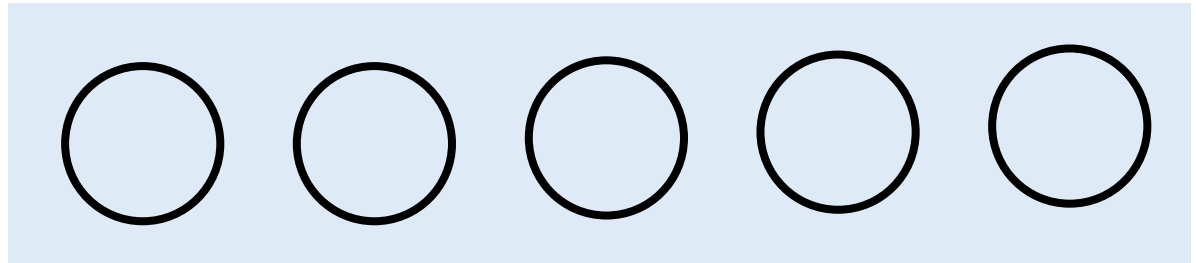
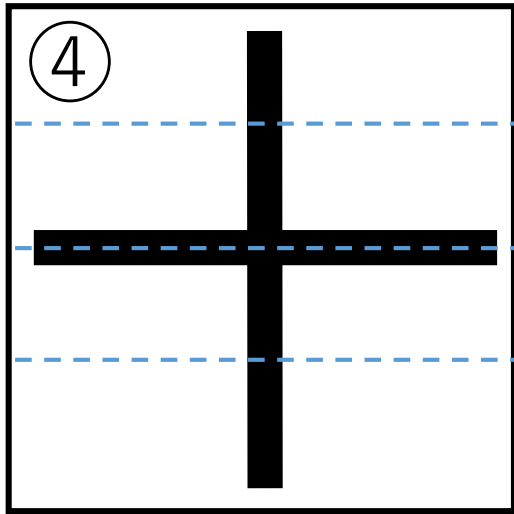

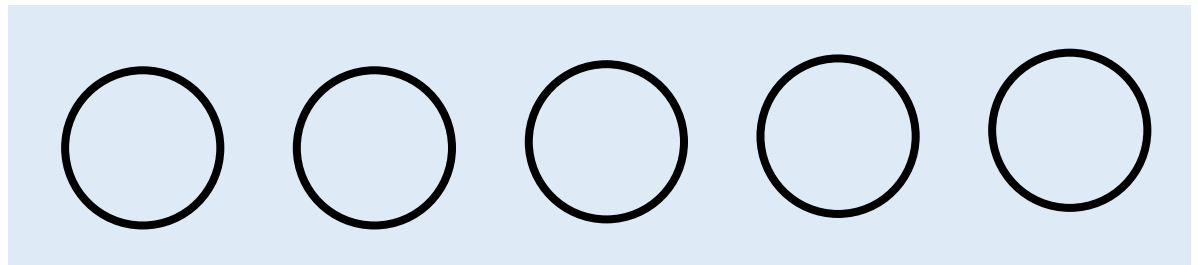
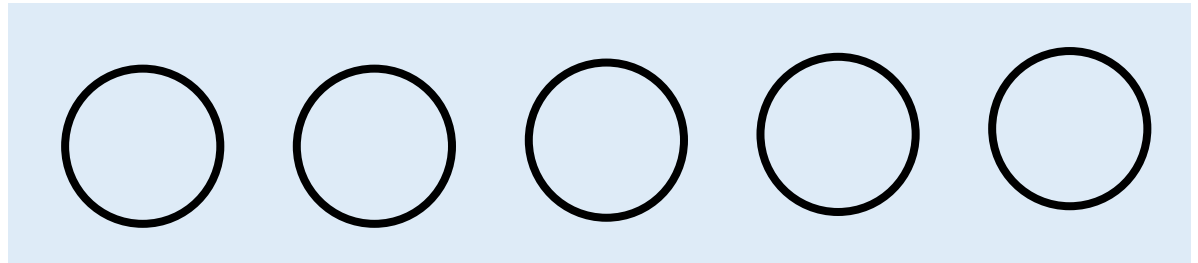
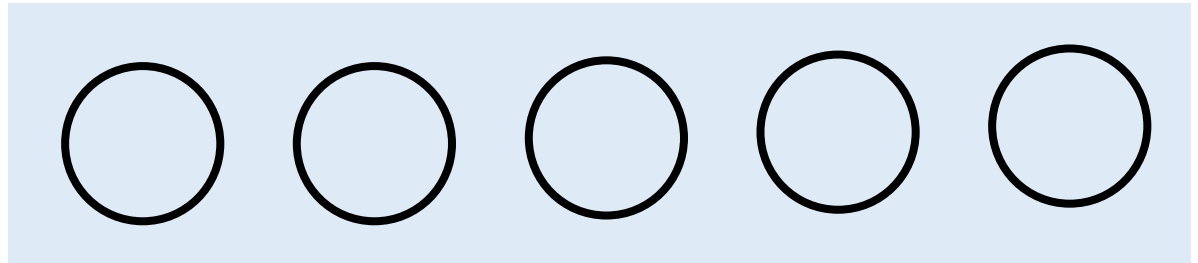
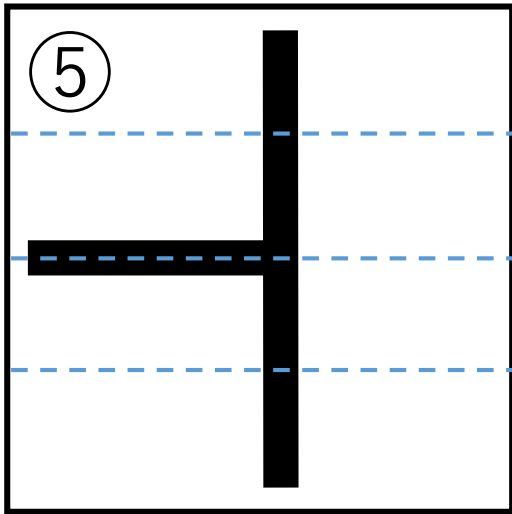

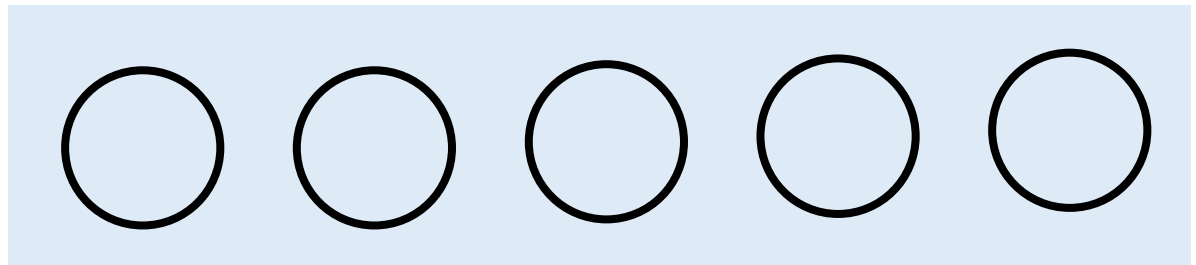
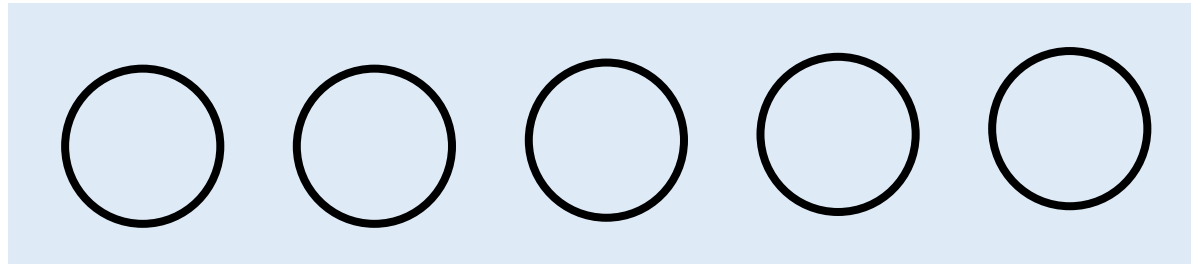
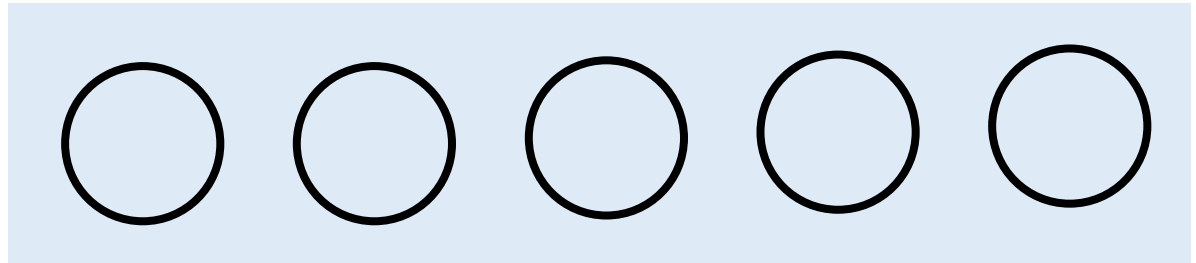
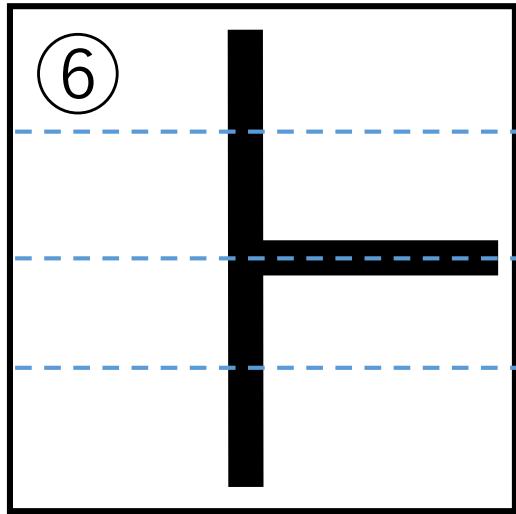

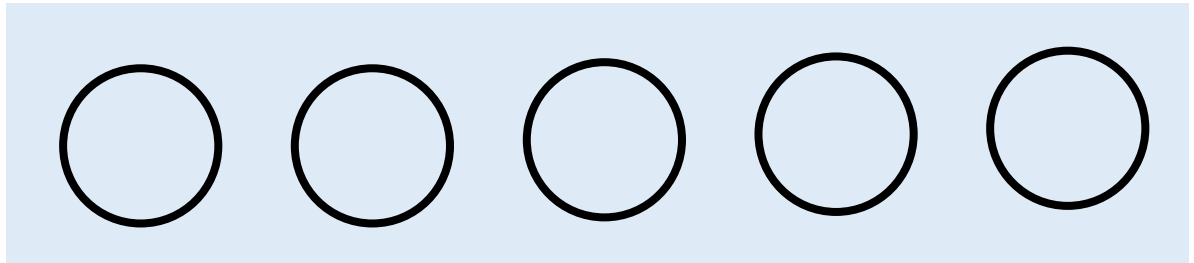
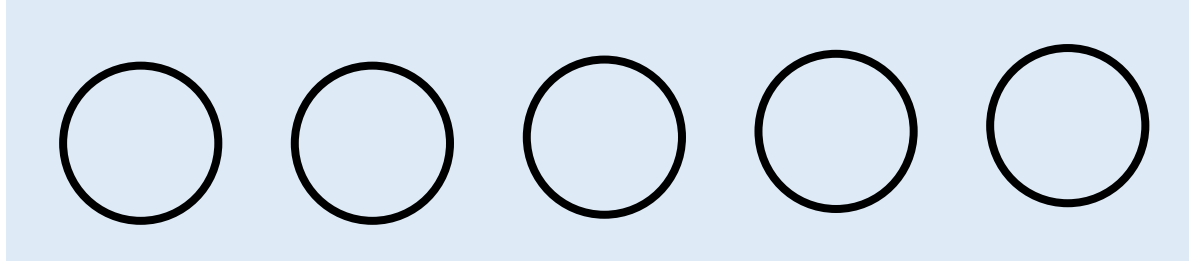
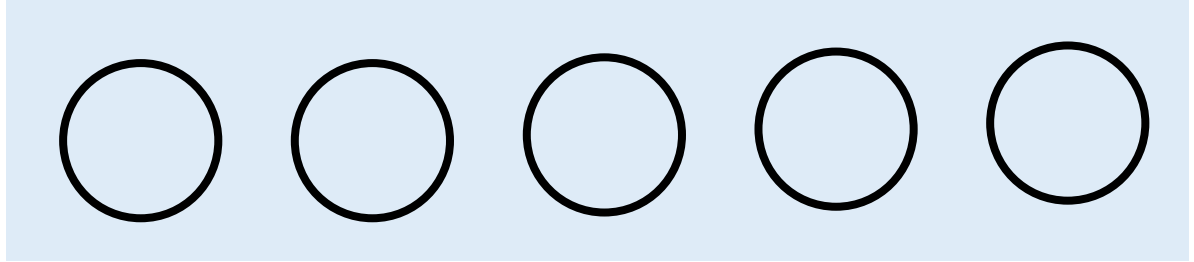
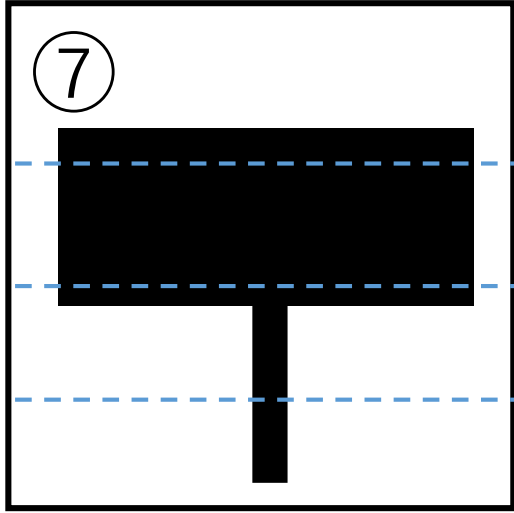

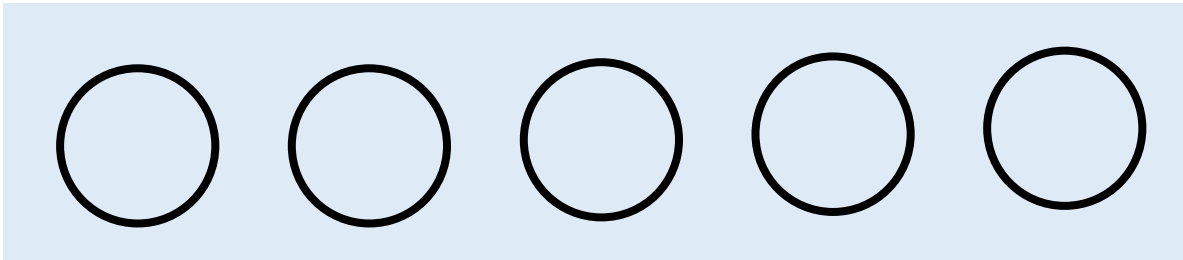
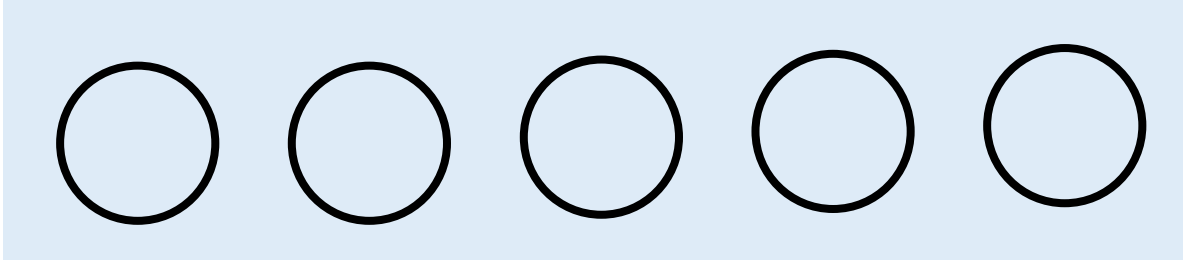
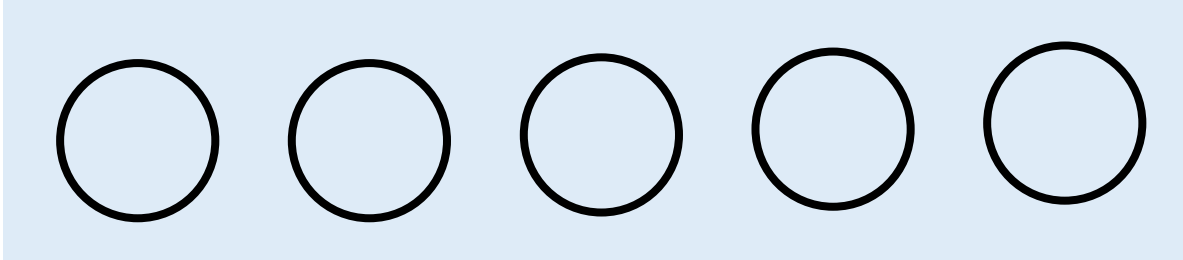
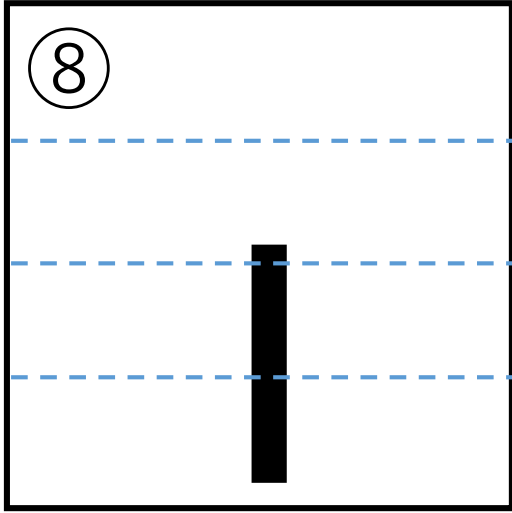

①

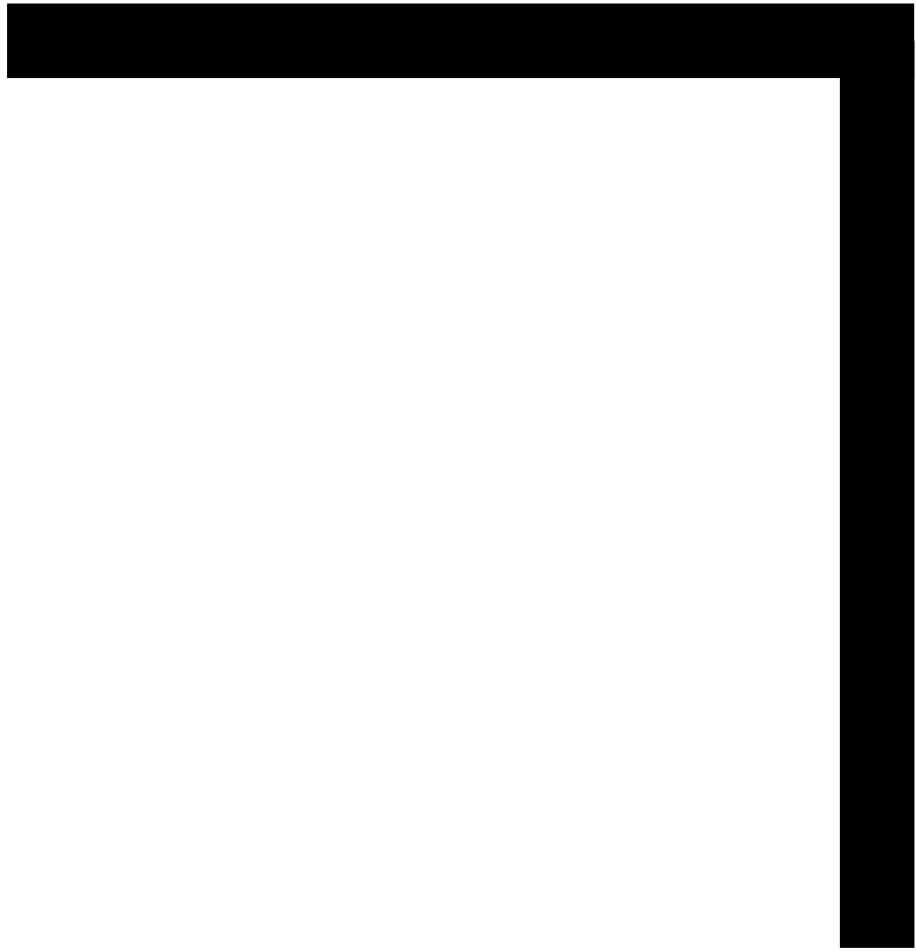

②

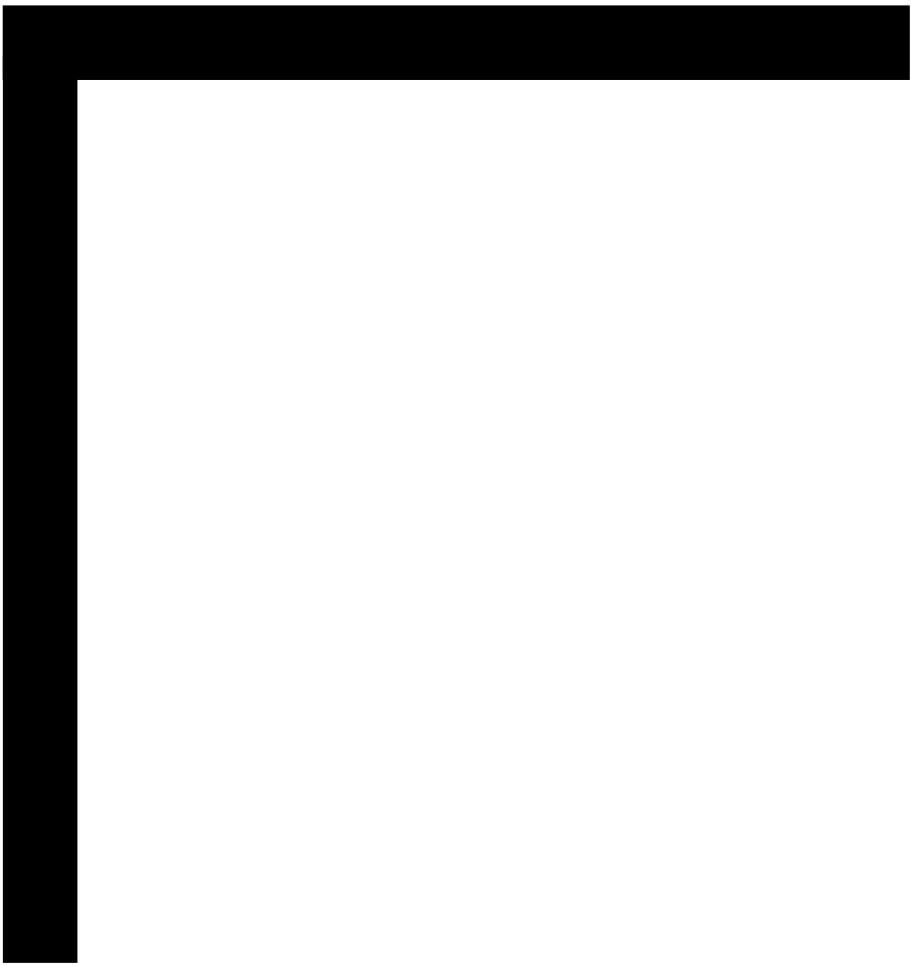

3

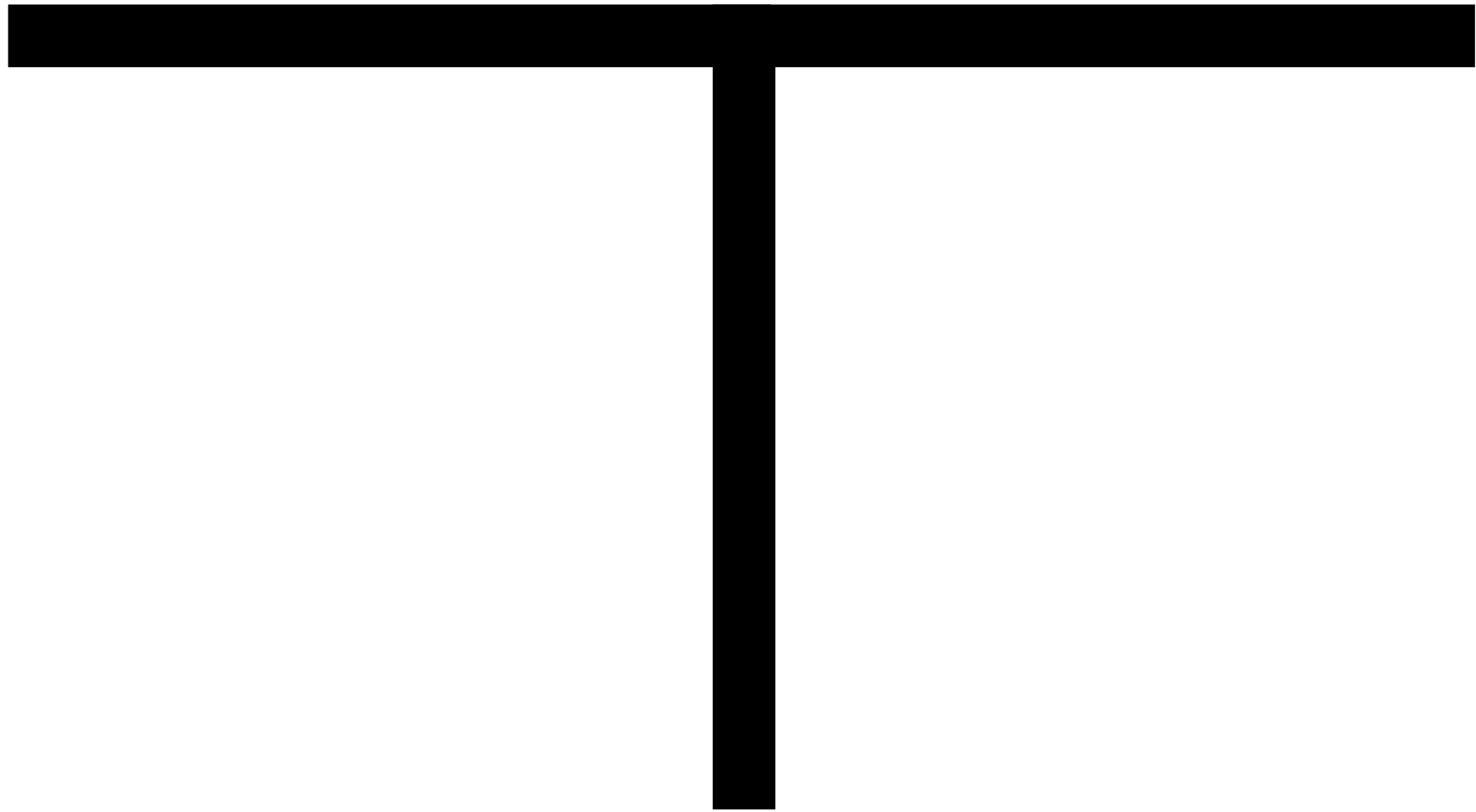

4

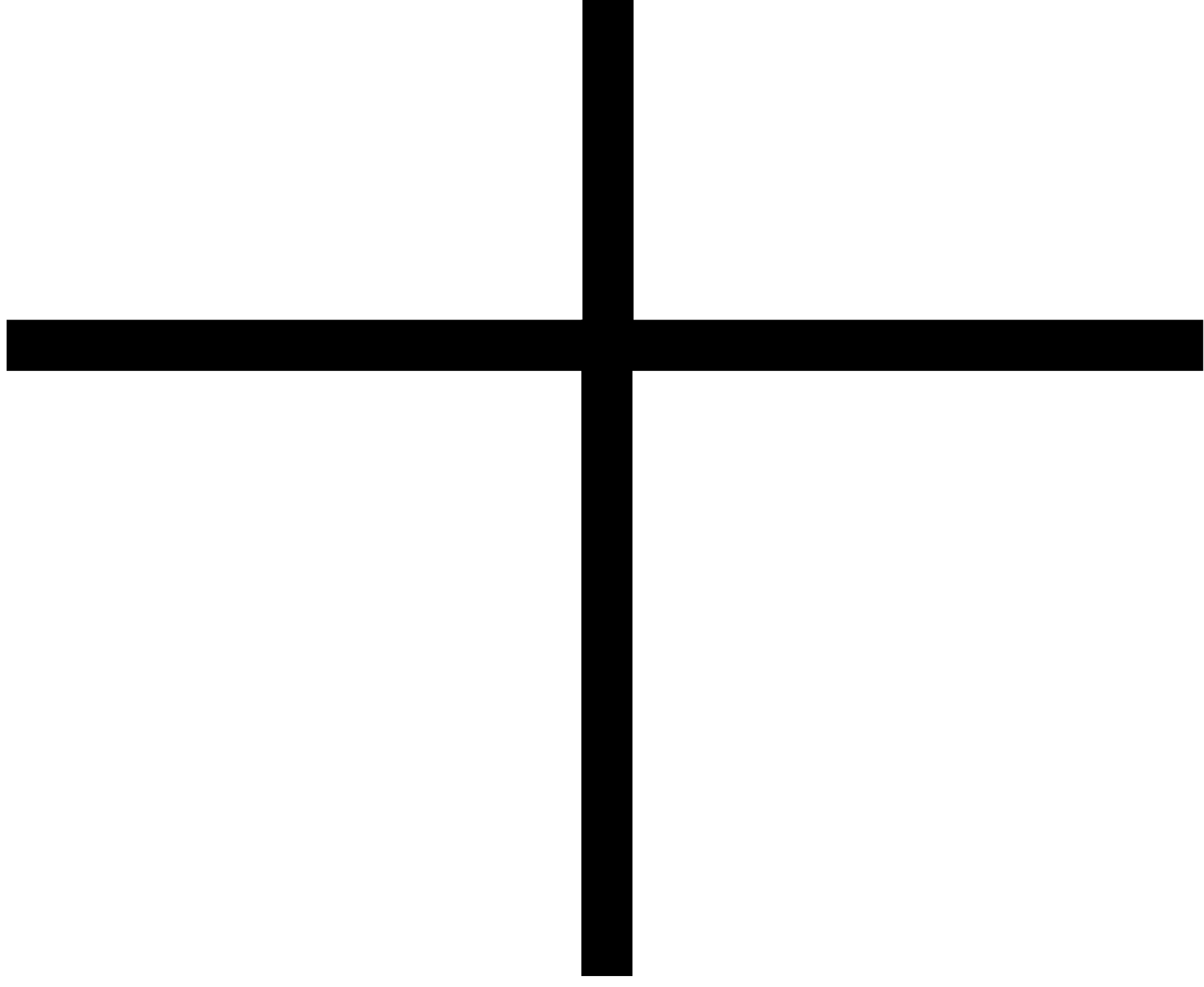

5



⑥

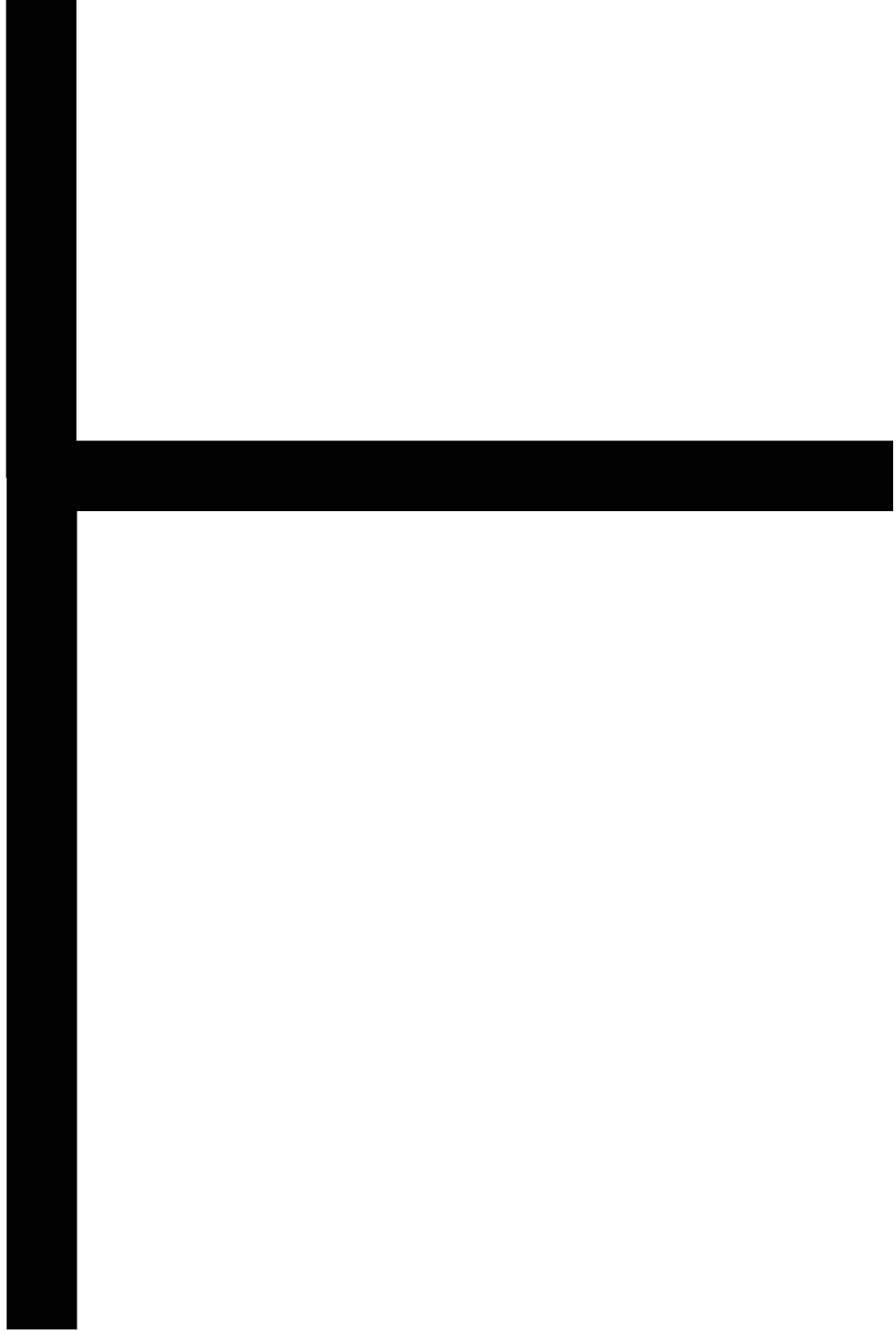

7

